

JC Series – 17" & 22" Faceted Reflector

Dimensions	Fixture Length		Fixture Width	Approx. Ship Wt.
	Min.	Max.		
JCS Series	20.1"	23.1"	17"	24 LBS.
JCL Series	20.3"	23.3"	22"	38 LBS.

Spacing Criteria: .7 – 1.8

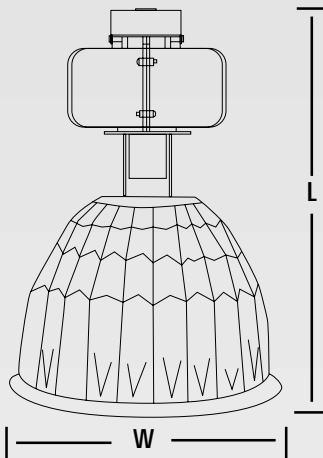

The heavy-duty JC Series fixture is designed for commercial and industrial applications. Its high efficiency glass lined reflector delivers consistent high light levels with low glare and little reflector maintenance.

Reflector

The 17" and 22" glass lined reflector resists dirt buildup, cleans easily with water only and provides high light levels with very low glare.

Ballast

The heavy duty die cast aluminum ballast housing has heat dissipating fins to extend ballast life. A multi-tap high power factor constant wattage autotransformer ballast is standard (480V is single tap). Linear reactor ballast 320W, 350W & 400W MH is available in 277V only.

Adjustable Distribution

The spring loaded Twist-N-Lok™ reflector attachment system allows for complete tool-free installation of the reflector. Simply pull *open* the spring loaded locking pins and snap *lock* the reflector in place.

Lamps

The JC Series will accommodate mogul base 175 - 1000W Metal Halide and 150 - 1000W HPS lamps. 1000W lamps have reduced jackets. Open rated Pulse Start Metal Halide systems must utilize an EX39 open rated mogul socket.

Mountings

Two mountings are available: direct hard wire or Hook, Cord & Plug (HCP). The slide box has an adjustable hook assembly for balancing the fixture. Also, the easy access wiring chamber provides additional room for wiring make-up.

Labels

The JC Series is UL listed for damp locations UL1598, suitable for ambient operation as follows: 55°C for 1000W and 65°C for all other wattages.

Warranty

The JC Series sold by C.E.W. Lighting, Inc., unless otherwise specified, will be warranted to be free of defects in materials and workmanship under normal use and service for a period of five (5) years from date of shipment, 175W-1000W. Lower wattages will be warranted for (2) years. If found to be defective by us, we will replace the non-performing components.



55°, 65° Ambient Rated



LISTED FOR DAMP LOCATIONS
CONSULT FACTORY FOR CUL AVAILABILITY

I.E.S. photometrics available by e-mail or on disk

17" Faceted

Cat #: JCS0240, JCS0440
Lamp: 400W Clear MH
Lumens: 38,000
Socket Position: 5
Certified Test Report: 35-174981-00
IES File: ECS440M.IES
Spacing Criteria: 1.5 max.

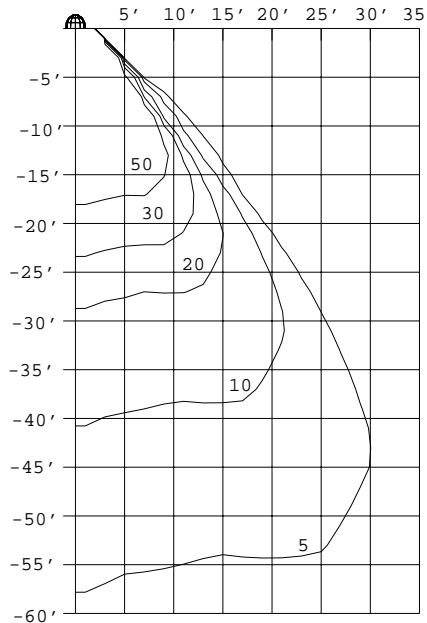

22" Faceted

Cat #: JCL0499
Lamp: 1000W Clear MH
Lumens: 110,000
Socket Position: 5
Certified Test Report: 35-174989-00
IES File: ECI499M.IES
Spacing Criteria: 1.5 max.

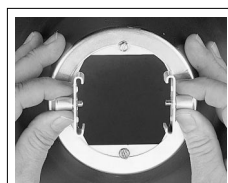
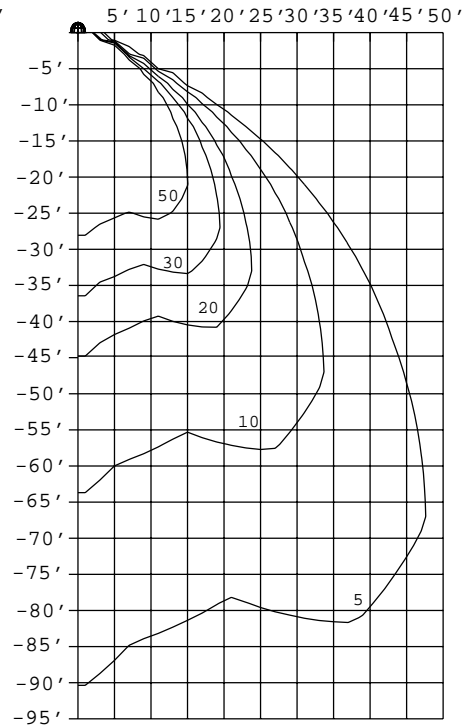

Twist-N-Lok™ – Locked

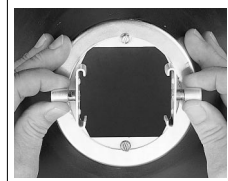

Twist-N-Lok™ – Open

JC Series Ambient Temperature Ratings

Fixture Wattage	Open		Enclosed	
	55°C	65°C	55°C	65°C
175W	yes ^①	yes ^①	yes	yes
250W	yes ^①	yes ^① JCL only	yes	yes ^② JCL only
320W	yes ^①	yes ^① JCL only	yes	yes ^② JCL only
350W	yes ^①	yes ^① JCL only	yes	yes ^② JCL only
400W	yes ^①	yes ^① JCL only	yes	yes ^② JCL only
450W	yes ^①	yes ^① JCL only	yes	yes JCL only
1000W	yes ^① JCL only		yes ^② JCL only	

- ① HPS or Open Rated MH
- ② Reduced Jacketed Lamp Only
- ③ Glass Lens & Reduced Jacket Lamp Only



To build catalog numbers refer to inside front cover

JC Series – 17" & 22" Faceted Reflector

Wattage Range:
150-1000W



Lamp Included

Reflector Size	Wattage Lamp	Catalog Numbers			
		Enclosed or Restricted Lamp Split-Box	Enclosed or Restricted Lamp Hook, Cord & Plug	Open Rated Lamp Split-Box	Open Rated Lamp Hook, Cord & Plug
17"	175W MH	JCS0417-(a)(b)*	JCS2417-(a)(b)*		
	175W MH/PS	JCS0817-(a)(b)*	JCS2817-(a)(b)*		
	200W MH/PS	JCS0820-(a)(b)*	JCS2820-(a)(b)*		
	250W MH	JCS0425-(a)(b)*	JCS2425-(a)(b)*	JCS0225-(a)(b)	JCS2225-(a)(b)
	250W MH/PS	JCS0825-(a)(b)*	JCS2825-(a)(b)*	JCS0925-(a)(b)	JCS2925-(a)(b)
	320W MH/PS	JCS0832-(a)(b)*	JCS2832-(a)(b)*	JCS0932-(a)(b)	JCS2932-(a)(b)
	320W MH/PS Reactor	JCS0832-R2(b)*	JCS2832-R2(b)*	JCS0932-R2(b)	JCS2932-R2(b)
	350W MH/PS	JCS0835-(a)(b)*	JCS2835-(a)(b)*	JCS0935-(a)(b)	JCS2935-(a)(b)
	350W MH/PS Reactor	JCS0835-R2(b)*	JCS2835-R2(b)*	JCS0935-R2(b)	JCS2935-R2(b)
	400W MH	JCS0440-(a)(b)	JCS2440-(a)(b)	JCS0240-(a)(b)	JCS2240-(a)(b)
	400W MH/PS	JCS0840-(a)(b)*	JCS2840-(a)(b)*	JCS0940-(a)(b)	JCS2940-(a)(b)
	400W MH/PS Reactor	JCS0840-R2(b)*	JCS2840-R2(b)*	JCS0940-R2(b)	JCS2940-R2(b)
	400W MH-MSX	JCS0740-(a)(b)*	JCS2740-(a)(b)*		
	450W MH/PS	JCS0845-(a)(b)*	JCS2845-(a)(b)*	JCS0945-(a)(b)	JCS2945-(a)(b)
	150W HPS			JCS0515-(a)(b)	JCS2515-(a)(b)
	250W HPS			JCS0525-(a)(b)	JCS2525-(a)(b)
	400W HPS			JCS0540-(a)(b)	JCS2540-(a)(b)

22" – JCL Series Order Information					
22"	175W MH/PS	JCL0817-(a)(b)+	JCL2817-(a)(b)+	JCL0917-(a)(b)	JCL2917-(a)(b)
	320W MH/PS	JCL0832-(a)(b)+	JCL2832-(a)(b)+	JCL0932-(a)(b)	JCL2932-(a)(b)
	320W MH/PS Reactor	JCL0832-R2(b)+	JCL2832-R2(b)+	JCL0932-R2(b)	JCL2932-R2(b)
	350W MH/PS	JCL0835-(a)(b)+	JCL2835-(a)(b)+	JCL0935-(a)(b)	JCL2935-(a)(b)
	350W MH/PS Reactor	JCL0835-R2(b)+	JCL2835-R2(b)+	JCL0935-R2(b)	JCL2935-R2(b)
	400W MH	JCL0440-(a)(b)	JCL2440-(a)(b)	JCL0240-(a)(b)	JCL2240-(a)(b)
	400W MH/PS	JCL0840-(a)(b)+	JCL2840-(a)(b)+	JCL0940-(a)(b)	JCL2940-(a)(b)
	400W MH/PS Reactor	JCL0840-R2(b)+	JCL2840-R2(b)+	JCL0940-R2(b)	JCL2940-R2(b)
	400W MH-MSX	JCL0740-(a)(b)+	JCL2740-(a)(b)+		
	450W MH/PS	JCL0845-(a)(b)+	JCL2845-(a)(b)+	JCL0945-(a)(b)	JCL2945-(a)(b)
	750W MH/PS	JCL0875-(a)(b)+	JCL2875-(a)(b)+	JCL0975-(a)(b)	JCL2975-(a)(b)
	1000W MH	JCL0499-(a)(b)+**	JCL2499-(a)(b)+**		
	1000W MH/PS	JCL0899-(a)(b)+**	JCL2899-(a)(b)+**		
	1000W MH-MSX	JCL0799-(a)(b)+**	JCL2799-(a)(b)+**		
	400W HPS			JCL0540-(a)(b)	JCL2540-(a)(b)
	1000W HPS			JCL0599-(a)(b)	JCL2599-(a)(b)

(a) Voltage Suffix Key: Indicate voltage in space (a)

Description						
120 Volt (1)	277 Volt (2)	208 Volt (3)	240 Volt (4)	480 Volt (5)	Multi-tap (M)	120 - 480V (M5)
						400W MH Only

(b) Options: Indicate options in space (b) (Factory Installed)

Description	SUFFIX
High-2-Low Option (175-1000W MH, 250-1000W MH/PS & 250-1000W HPS) ¹¹	H
Fusing	
Single (120V & 277V) Indicate Voltage in Suffix (a)	F
Dual (208-240-480V) Indicate Voltage in Suffix (a)	J
Quartz Standby	Q
Potted Ballast	E
Coated Lamp	C

Accessories: (Field Installed)	Catalog Number	Catalog Number
Description		
Flat Glass Lens -	17" & 22" Shade Options & Accessories on Pages 134 - 135	
Wire Guard -	17" & 22" Shade Options & Accessories on Pages 134 - 135	
Mounting Hook - 3/4" Thread with Safety Snap-Lok™	HKSC	
Ballast/Reflector Safety Chain - 6'	SC-6	
Swivel Pendant Mount 3/4" x 18" long (other lengths available upon request)	SP	
Dust Tight	G	
Wet Location	W	

* Includes SDC17LA - Glass lens enclosure
+ Requires Bottom Lens - SDC22LA

¹¹ Must be used with components on pages 136-139
^{**} Reduced Jacketed Lamp

Mountings

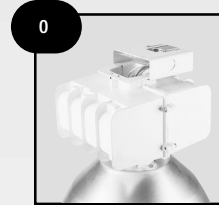

Slide Box

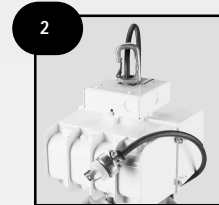

Hook, Cord & Plug

Accessories

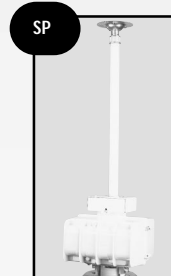

Swivel Pendant