

STSP Series Square Tapered Steel Poles

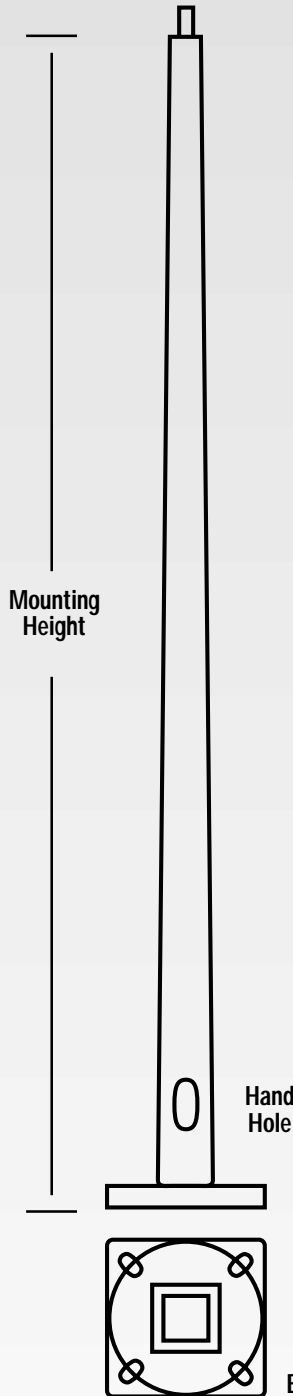

Shaft

The STSP Series pole shaft conforms to ASTM A595 Grade-A and is supplied in 11 and 7 gauge thickness. The shaft includes a peripherally reinforced hand hole furnished with a cover and ground lug.

Base Plate

The base plate is fabricated from structural quality hot rolled carbon steel plate conforming to ASTM A36. The structurally engineered base includes eight heavy wall reinforcing vertical gussets. The base telescopes and is circumferentially welded to the shaft at both the outside top and inside bottom of the base.

Anchorage

The 4 anchor bolts are fabricated from hot rolled steel bar with a minimum yield strength of 50,000 psi. Bolts have an "L" bend on one end and are threaded on the other end. Bolts are galvanized 12" from the top of the thread and are furnished with two nuts and two washers. See next page for anchor bolt specifications and a diagram.

Base Cover

The base cover is fabricated from heavy wall aluminum construction. The two piece cover entirely conceals the base.

Standard Finish

The STSP Series is finished with weather resistant polyester powder coat paint.

Fixture Mounting

STSP Series mounting options use either a 2-3/8" or a 2-7/8" tenon. See next page for mounting codes.

Square Tapered Steel Poles 11 Gauge

Pole Height	Catalog Number	Base Outer Diameter	Pole EPA Ratings			Max. Fix. Wt. (lbs) @ 80 MPH	Shipping Wt. (lbs.)
			80	90	100		
20'	STSP-525A200-(a)(b)	5.25	18.0	13.8	10.7	452	155
25'	STSP-600A250-(a)(b)	6.0	16.8	12.6	9.5	422	205
30'	STSP-641A300-(a)(b)	6.41	13.6	9.8	7.0	340	260
35'	STSP-681A350-(a)(b)	6.81	10.7	7.3	4.8	269	305
39'	STSP-718A389-(a)(b)	7.18	8.6	5.4	3.0	215	345

Square Tapered Steel Poles 7 Gauge

20'	STSP-550E200-(a)(b)	5.50	30.5	24.0	19.0	764	235
25'	STSP-641E250-(a)(b)	6.41	28.5	22.5	18.2	713	310
30'	STSP-641E300-(a)(b)	6.41	23.6	17.9	13.7	590	375
	STSP-713E300-(a)(b)	7.13	27.4	21.6	17.3	687	431
35'	STSP-713E350-(a)(b)	7.13	23.4	17.4	13.0	585	475
	STSP-788E350-(a)(b)	7.88	25.7	18.8	13.8	643	540
39'	STSP-713E389-(a)(b)	7.13	19.3	14.2	10.4	483	500
45'	STSP-788E450-(a)(b)	7.88	16.0	11.1	7.4	400	620
	STSP-875E450-(a)(b)	8.75	23.5	16.6	11.4	588	730
50'	STSP-881E500-(a)(b)	8.81	19.4	13.2	8.7	485	780

Other sizes available upon request.

(a) Pole Finish: Indicate finish in space (a)

Description	Prime	Bronze	Black	Galvanized
	P	BZ	BK	GLV

b) Mounting Code: See detail next page.

**Above information is only a guide.
Check manufacturer's specifications for correct data.**

Mounting Code

b) Mounting Code: Indicate mounting in space (b)

Description	SUFFIX (b)
2-3/8" Tenon	2
One Fixture (Direct Mount)	DM10
Two Fixtures 90° (Direct Mount)	DM290
Two Fixtures 180° (Direct Mount)	DM2180
Three Fixtures 120° (Uses RTA3120 Adaptor)	SPB14
Three Fixtures 90° (Direct Mount)	DM390
Four Fixtures 90° (Direct Mount)	DM490

Mounting Hole Detail

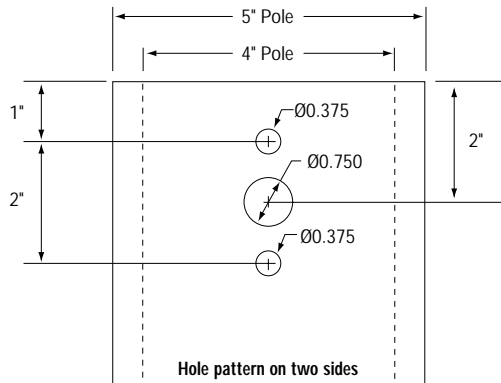

BC = Bolt Circle Diameter
 BP = Bolt Projection (6" of thread)
 D = Anchor Bolt Diameter
 L = Anchor Bolt Length
 W = Anchor Bolt Width

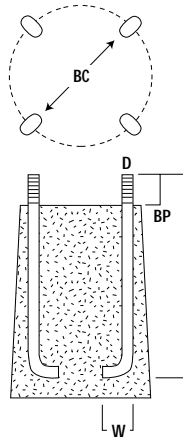

Check your pole manufacturers specifications for the correct bolt patterns and anchor bolts.

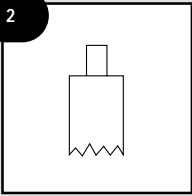
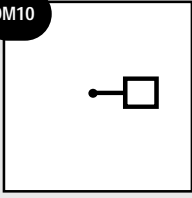
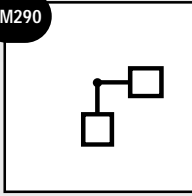
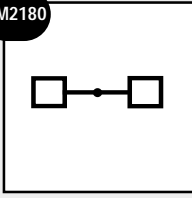
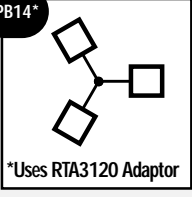
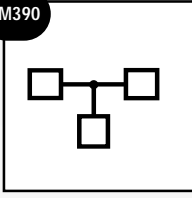
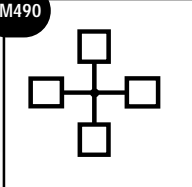
2		2-3/8" Tenon
DM10		One Fixture
DM290		Two Fixtures 90°
DM2180		Two Fixtures 180°
SPB14*	 <small>*Uses RTA3120 Adaptor</small>	Three Fixtures 120°
DM390		Three Fixtures 90°
DM490		Four Fixtures 90°